

# HouseWrap Applications

System R-Value: R-4.17 Horizontal Heat Flow Only

## Installation Method (Existing Walls)

1. ESP Low-E® Housewrap is installed over exterior wall sheathing, make sure reflective side faces out: foil flange faces down.
2. Determine width of ESP Low-E® HouseWrap being used (4', 5', 6') for initial wrap (lowest point of wall surface)
3. Measure from sill plate up the wall, mark wall at level of determined width less 1" i.e. 5' ESP Low-E® HouseWrap mark at 59"
4. Snap chalkline around perimeter
5. Starting at the corner of the preferred exterior wall unroll ESP Low-E® Housewrap in a horizontal manner. Fasten using corrosion resistant staples having minimum 1" wide crown, corrosion resistant nails having minimum 3/8" heads or corrosion resistant nails having minimum 1" diameter plastic heads. Fasteners to be spaced a maximum of 16" both vertically and horizontally.
6. When rolling ESP Low-E® Housewrap over door and window openings: If windows and doors have been set, trim ESP Low-E® HouseWrap as close to window or door opening as possible and perform detailing as per door / window manufacturer and or code standards.
7. The bottom side of the ESP Low-E® Housewrap should extend over sill plate by minimum 1".
8. When applying second horizontal run of ESP Low-E® Housewrap butt foam ends together allowing foil flange to overlap 2". Make certain foil flange is to the outside to ensure water drainage plane downward.
9. Tape all vertical and horizontal flange seam areas with foil tape.
10. Continue method until ESP Low-E® Housewrap covers both top plates.
11. Use foil tape to repair areas that have been torn or compromised. (See page 7)
12. **Foil is a conductor of electricity. Use extreme caution when working with ESP Low-E® Housewrap around power lines, wiring and electrical devices.**

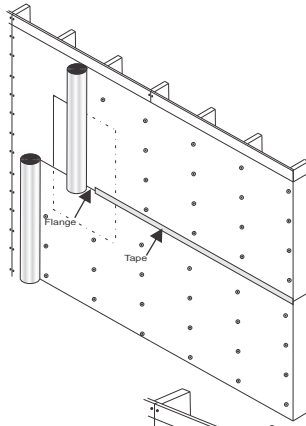

1. When coming to the end of existing roll in use, leave up to 12 inches of product unattached to wall system.
2. Remove new roll from packaging
3. Unroll ESP Low-E® Housewrap to desired area making sure that product is plumb and square with housewrap already in place and also overlap material past the end of previous material by approx 8 inches.
4. Locate center of overlapped materials and make common splice through both layers of material using utility knife.
5. Remove cut material from end of previous roll and start of new roll
6. Apply Low-E Tape over common splice, then continue installing ESP Low-E® Housewrap as described in Figure 1
7. If vertical splice is not performed, product must be overlapped by minimum of 6"

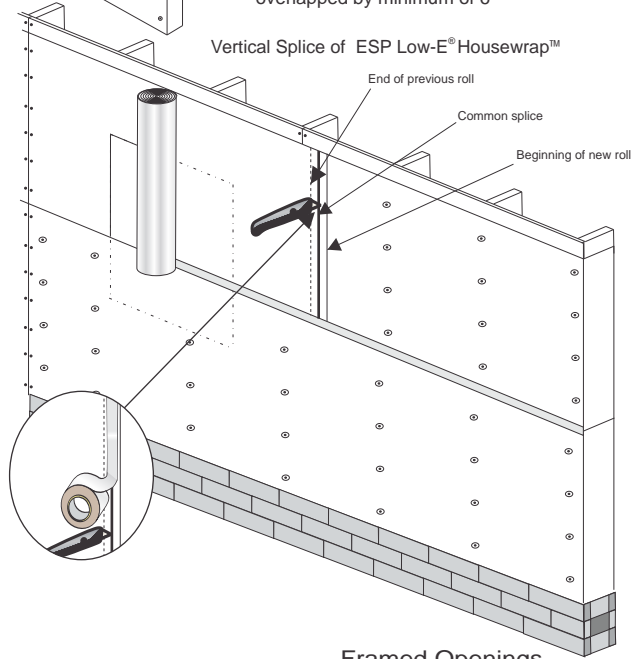

## Penetration Installation Diagrams

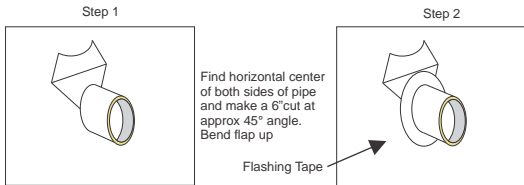

Wrap around outside diameter of pipe using approved flashing tape (for best seal use approved caulk around pipe prior to flashing tape).

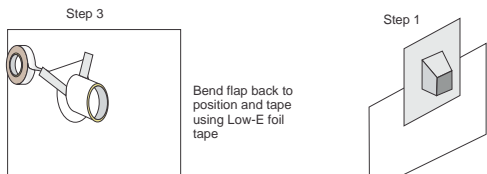

Place dryer vent in designated location allowing vent flashing to cover housewrap on lower half (vent flashing area to touch sheathing on top half)

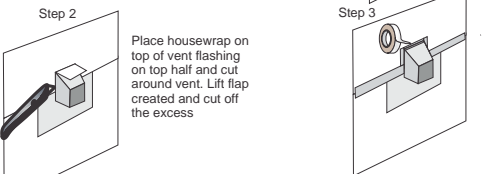

Tape lateral seam and around vent obstruction. For best seal use approved caulk around vent prior to taping.

## Tears and Holes Repair

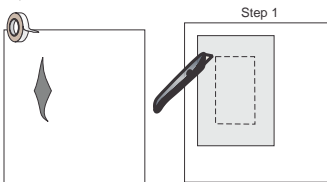

For simple tears in ESP Low-E® HouseWrap apply Low-E foil tape completely over torn area and squeegee area for best adhesion

For larger tears and or holes place piece of ESP Low-E® Housewrap over compromised area (Be sure that piece being placed on top of compromised area is larger than damaged area) Make common splice through both layers. Remove excess top layer and compromised area that was cut out.

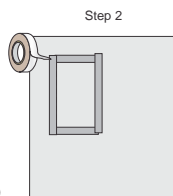

Place material into opening created and tape using Low-E foil tape

## Framed Openings

When installing ESP Low-E® Housewrap over the exterior of structure be sure to run product horizontally over entire wall including framed openings. (please refer to page 5 for more detailed instructions)

Once ESP Low-E® Housewrap has been securely fastened to exterior sheathing make cuts as shown in Figure 2. Try not to cut past exterior side of framed opening (exception for top of framed opening) but in the event that occurs use Low-E foil tape to repair area that was compromised.

1. An additional flap should be cut above the top exterior side of framed opening for the installation of head flashing.
2. Bend flap away from wall to allow installation of window and flashing
3. Apply window and head flashing
4. Reset ESP Low-E® Housewrap and tape seams

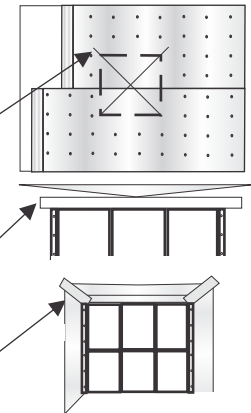

Once side and bottom flaps have been cut, bend these flaps toward the interior of structure using staples or adhesive to attach ESP Low-E® Housewrap to the face of the jamb.

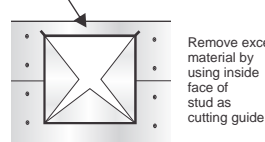

Remove excess material by using inside face of stud as cutting guide

Follow door and window manufacturers instructions for flashing and installation relating to their respective products.

SYSTEM R-VALUE CALCULATIONS FOR THIS ASSEMBLY WERE PERFORMED BY R & D SERVICES REPORT # RD03224

# Pre Engineered Steel Applications

## Commercial Metal Roofing

Average System R-Value: Down R- 11.04, Up R- 7.39

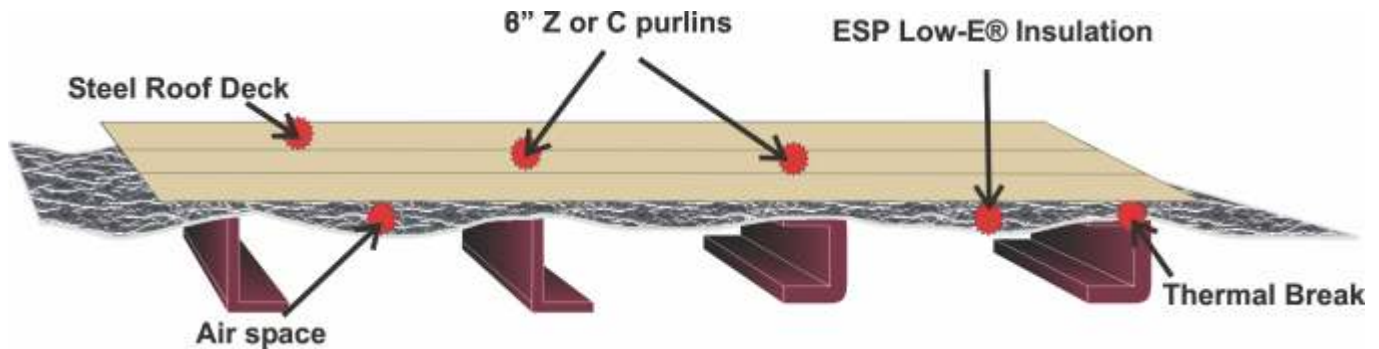

Average System R-Value: Down R- 21.04 (3" Fiberglass), Down R- 30.04 (6" Fiberglass)  
Up R- 17.38 (3" Fiberglass), Up R- 26.39 (6" Fiberglass)

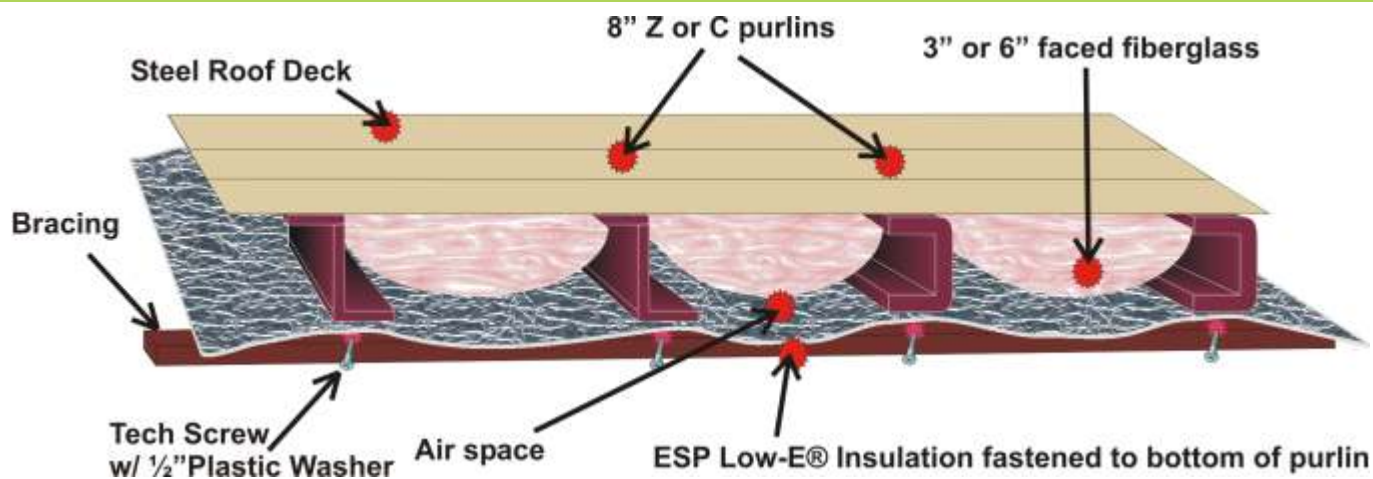

SYSTEM R-VALUES FOR ESP LOW-E® INSULATION AS PER ASTM C-976, AIR TO AIR, ADJUSTED TO MEET CRITERIA EQUIVALENT TO ASTM 1224

## ASHRAE 90.1 Compliance Application

Average System R-Value: R- 17.85 (3" Fiberglass) \*SDR, R- 21.73 (3" Fiberglass) \*SSR, R- 18.51 (4" Fiberglass) \*SDR  
R- 26.31 (6" Fiberglass) \*SDR, R- 30.30 (6" + 3" Fiberglass) \*SSR, \*SDR = Screw Down Roof \*SSR = Standing Seam Roof

### ESP Low-E® Insulation and ASHRAE 90.1 System Patent Pending

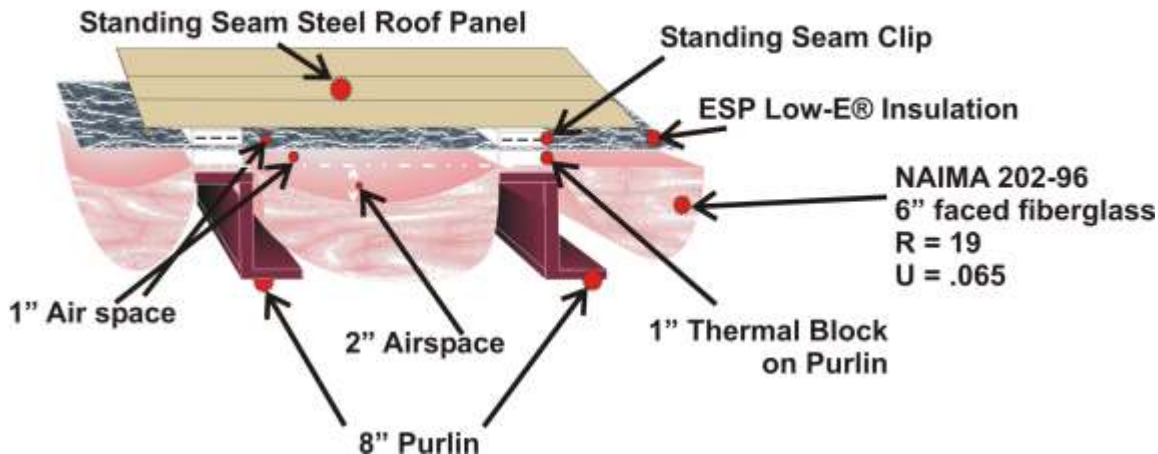

SYSTEM R-VALUES CALCULATED USING ENVSTD 4.0 ESP LOW-E® INSULATION AS R-11 SHEATHING

# Wall Applications

## Wall Application with Low-E & Mass Insulation (2X4) & (2X6)

System R-Value: R- 18.91, Horizontal Heat Flow Only

The first step in this application is to install mass insulation in the wall cavity. Next, install Low-E Insulation Tab Material with the tab flush to the outside of the stud. It is recommended that 1/2" staples be applied approximately every 6" along tab to fasten Low-E. All seams should be taped securely with Low-E Tape. Cover the face of each stud with tape and all seams around electrical boxes should be taped.

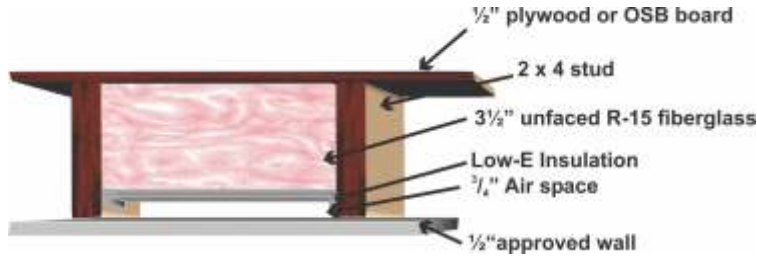

System R-Value: R- 22.75, Horizontal Heat Flow Only

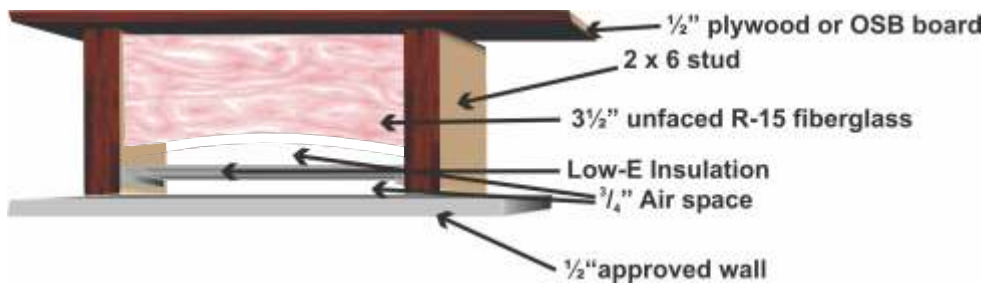

SYSTEM R-VALUES FOR THESE INSTALLATION METHODS WERE CALCULATED USING DATA FROM THE ASHRAE HANDBOOK OF FUNDAMENTALS

## Wall Application with 1 Layer Low-E Insulation (No Mass Insulation)

System R-Value: R- 9.06, Horizontal Heat Flow Only

Install Low-E Insulation Tab Material with the tab centered within the stud cavity. It is recommended that 1/2" staples be applied approximately every 6" along tab to fasten Low-E. All seams are taped securely with Low-E Tape. All seams around electrical boxes are taped. To achieve a vapor barrier, all seams must be taped securely with Low-E tape.

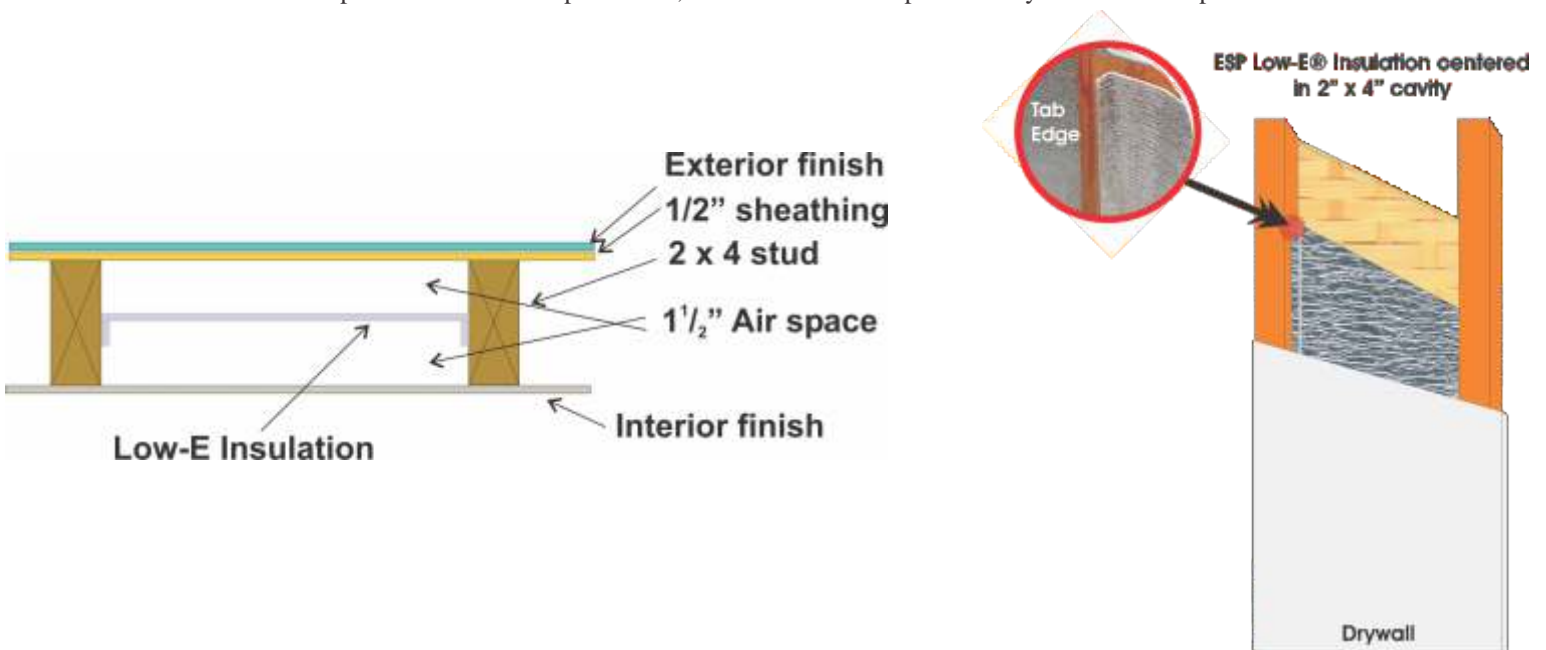

CALCULATIONS FOR THIS ASSEMBLY WERE PERFORMED BY R & D SERVICES REPORT # RD03224