

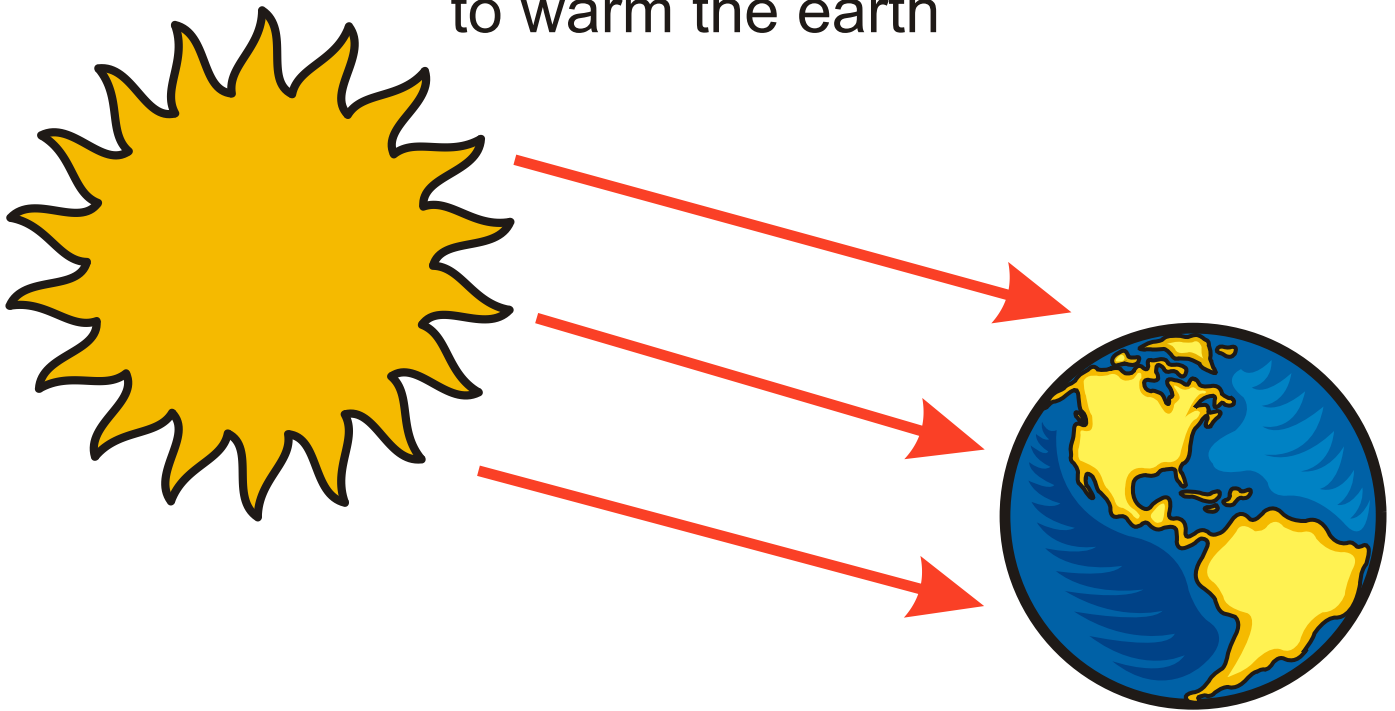

Environmentally Safe Products, Inc.

Low-E Insulationtm

Radiant Energy from the sun
travels 93 million miles through space
to warm the earth



The warming of your world begins with Radiant Energy

**Protect your world with
The Power of Aluminum**

Install Low-E!

WHY DOES LOW-E WORK?

It's the Law!

The second Law of Thermodynamics, unlike man made laws, cannot be broken HEAT goes to COLD by:

CONDUCTION
CONVECTION, OR
RADIATION (INFRARED)

WHAT IS CONDUCTION?

When two surfaces come in contact, the warmer surface gives up heat to the cooler surface as can be seen with a glowing burner on a stove heating the pot it is in contact with. In a building this is limited primarily to studs connecting outer and inner surfaces

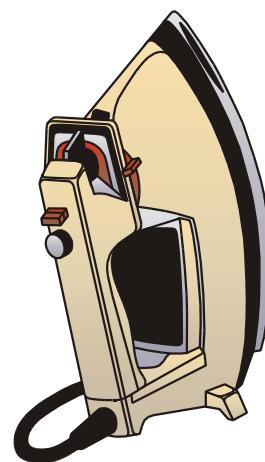

WHAT IS CONVECTION?

The movement of air as a result of air being warmed. Warm air rises seeking the coldest point. Convection is visible as wavy lines above a hot road. Convection is a major concern in the winter, but not in the summer.



WHAT IS INFRARED RADIATION?

Electromagnetic waves that can only be seen as part of the rainbow. It travels at 186,000 miles a second. Radiant energy travels in all directions seeking a cooler object to strike and then generates heat. Microwave ovens work on the same principles. Standard ovens heat the air, while a microwave heats what it sees.. Infrared is like microwaves at lower frequencies. Most of us do not understand microwaves or electricity but we use and enjoy the benefits of them. We may not understand infrared radiation but we can learn to make it work for us by learning how to control it.

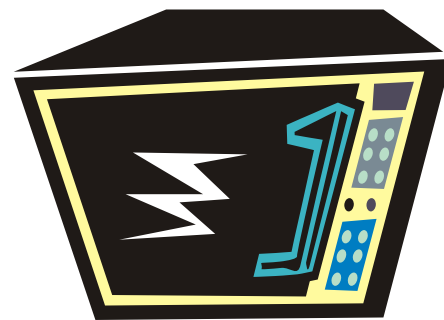

WHY DO WE INSULATE?

1) For Comfort

2) To reduce Energy Consumption

3) To help Control Condensation

What is an R-Value?

R-Value is the resistance to CONDUCTIVE heat flow. Conduction is only 3-7% of total heat loss. Mass Insulations only deal effectively with conduction.

Does R-Value have any effect on Infrared heat?

No, Most mass type insulations absorb Infrared like a sponge and store it like a battery allowing it to escape where we don't want it.

Does R-Value have any effect on convective heat loss?

Some. With recent studies by Oak Ridge National Laboratories they have found the colder your attic gets the more heat loss you have through convective currents. R-Values were found to be reduced by as much as 50% in the winter.

What about Moisture?

Most mass insulations absorbs moisture, especially in the winter when warm moist convective currents find a cold surface. Once this occurs, the R-Values drop tremendously and in extreme cases the insulation must be removed.

LETS TAKE A LOOK



Heat Loss through Walls

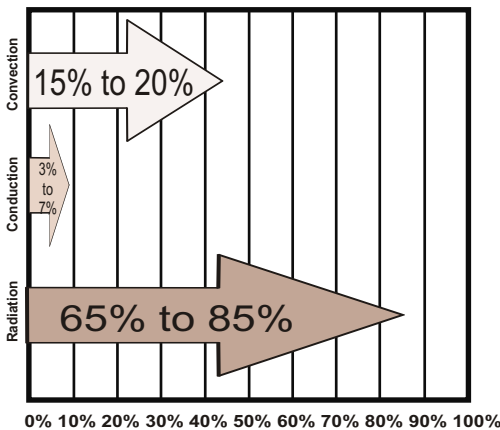

Heat Loss through Ceiling/Roof

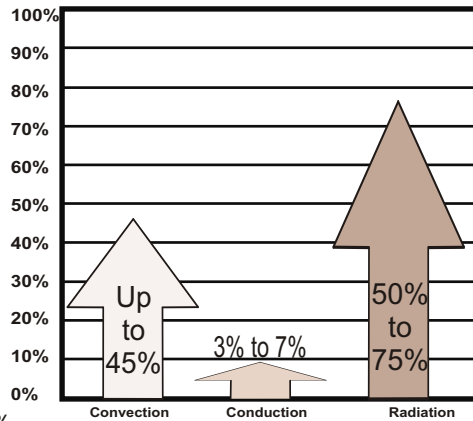

Summer Heat Gain

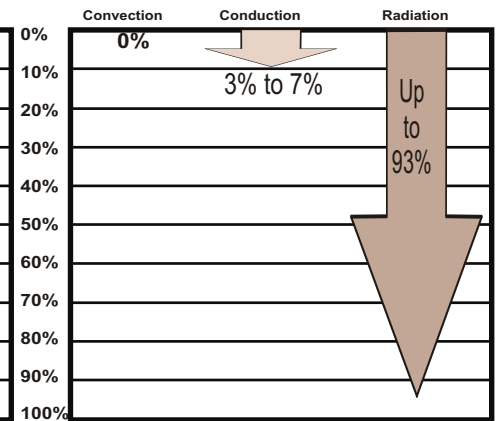

Now that we understand the three forms of heat loss and gain, the question is, "Is R-Value the only insulating option that we should think about?" When insulating we must take into consideration all three forms of heat loss and gain. Like millions of Americans you have done a great job solving conductive heat loss. What are you going to do about the other two?

Especially Infrared!

Is Infrared Blocking A New Form Of Insulating?

Infrared blocking, also known as reflective insulation and radiant barrier is one of the oldest forms of man made insulation. Dating back to the late 1700's, the first recorded form is the DeWares flask, which we know today as the glass lined Thermos bottle. Lets face it, there has never been anything better for keeping something hot in the winter, or cold in the summer than the Thermos bottle.

During World War II, the government confiscated aluminum shutting down the reflective insulation industry, thus ushering in the mass insulation industry, with asbestos, fiberglass and cellulose. All three are relatively new forms of insulation.

It wasn't until the 1960's, with the advent of the space program, that NASA brought back infrared blocking in astronauts suits, spacecraft insulation and just about anything they send into space. So many things in our everyday life are a result of space technology, like calculators and computers, isn't it time to benefit from Infrared Blocking!

*Turn your
building
into a
Thermos
bottle.*

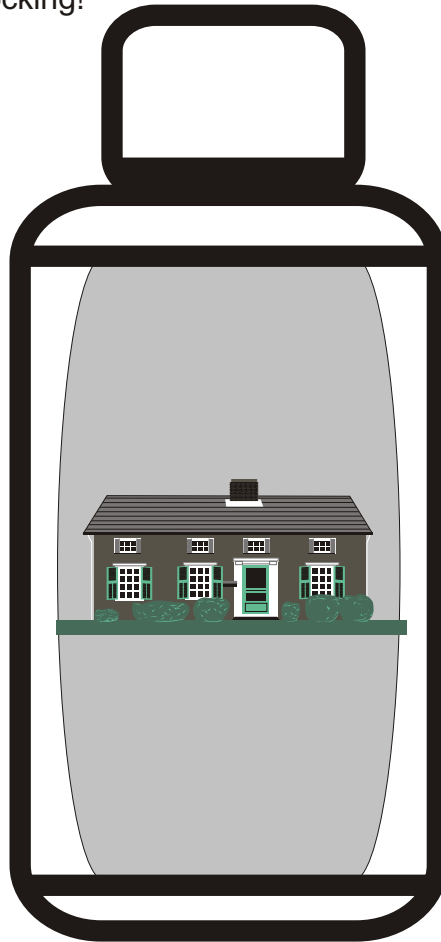

*By using
Low-E as
an
Infrared
Blocker*

In our everyday life we use Low-E benefits. When we bake a potato, we wrap it in aluminum. When we roast the Thanksgiving turkey, we cover the legs and back to keep it from scorching. Many food items are sealed in aluminum to keep them fresh.

For years, windows were the big problem in our homes when dealing with heat loss and gain, then they coated windows with a low-e coating, making them more efficient.

Isn't it time we make our walls and ceilings as efficient?

What does Low-E mean?

Understanding what Low-E means can be difficult. All surfaces have an “e” rating from .01 to 1.0. The “e” stands for emissivity, which is the ability of a surface to reradiate or give off radiant heat to a cooler surface. The lower the “e” rating, the lower the amount of radiant heat the surface will give off. For example, a wood stove surface has an “e” rating of 1.0, meaning that at 100° it will give off 100° in infrared. Cover it with a Low-E surface with an “e” rating of .03 then that surface will re-radiate only 3° in infrared!

All building products have an “e” rating, most of them over .80

The graph below demonstrates what Low-E surfaces can do for you

What can Low-E do for me?

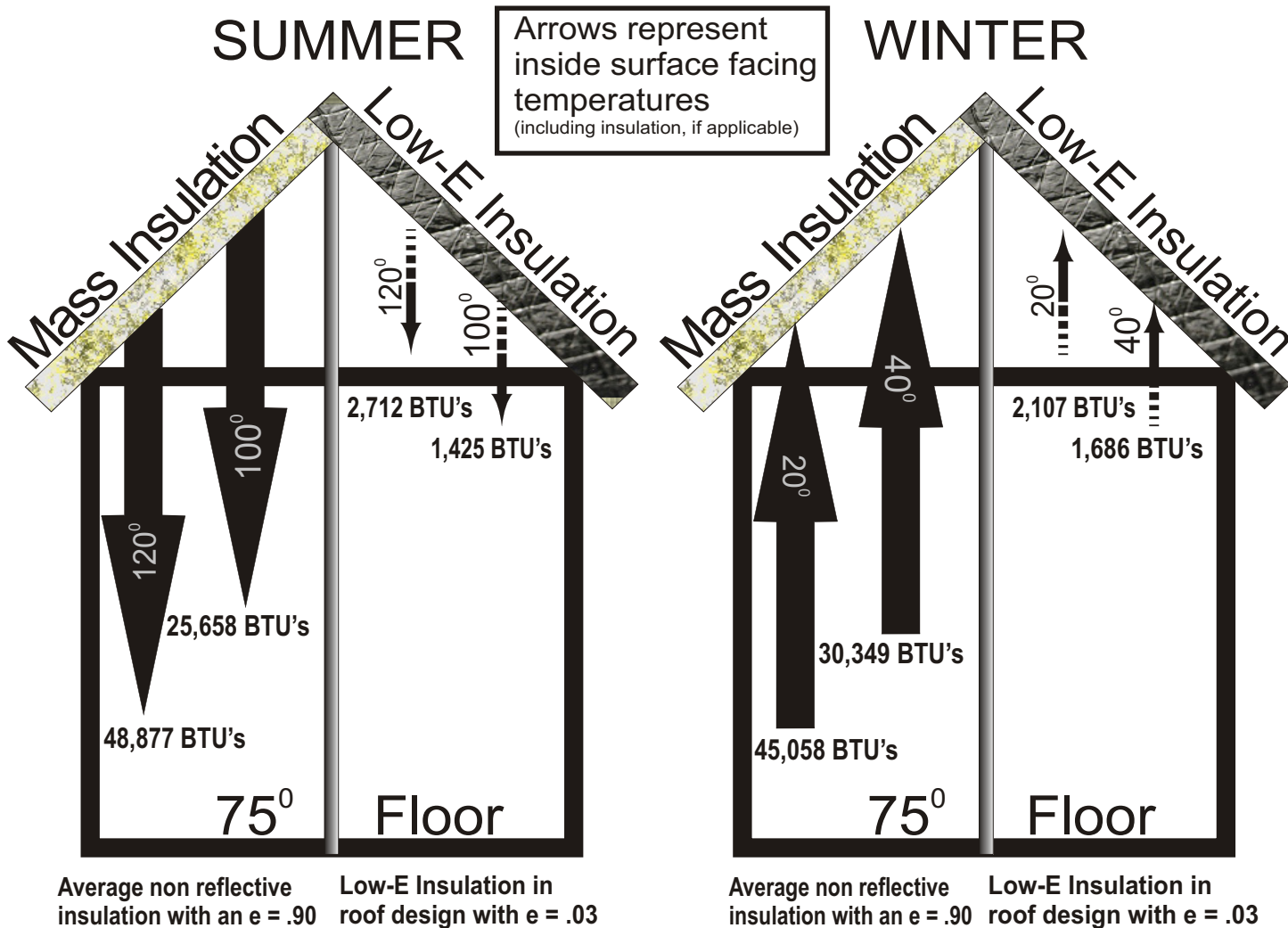

In the chart above we are demonstrating the difference in heat transfer with 75 degree floor temperature and using as an example, 120 degree summer inside roof temperature, with no Low -E, 48,877 btu's are transferred and with Low-E, 2,712 btu's are transferred.

Why is a Low-E surface highly recommended?

The left sides of the houses above are demonstrating the potential heat loss and gain in buildings using only mass type insulations.

The right sides of the house demonstrate the potential reduction in heat loss and gain by adding Low-E with the mass insulations.

Which would you rather be heating and cooling?

Comfort

If it wouldn't be for comfort, we wouldn't have much of an energy bill, would we! In the winter we would keep our buildings just above freezing, and in the summer **HOT**. Have you ever been in a room in the winter and you felt chilly, but when you looked at the thermostat it said warm? We've always been told "turn on the humidifier and turn up the heat." Chances are you were losing your body heat through infrared radiation especially if you were near a block wall or a window. What do the police use to look for criminals at night? What does the utility company use to check for heat loss? An infrared gun or infrared camera.

Environmental Standards

"Less appreciated is the fact that when walls are cold, the occupant can lose so much heat by radiation that he is cold, complains of drafts (which may or may not be present), and uncomfortable even with a relatively high air temperature. This loss of heat by radiation is especially noticeable if a person is sitting next to a window when the glass is cold. At the same time another occupant who is not losing heat by radiation may feel quite comfortable. Such situations cause great irritation among occupants of homes and offices. Since there is no universally acceptable standards in regards to mean radiant temperature, relative humidity, and air motion, air temperature is, in actual practice, the primary basis for design."

Encyclopedia Britannica 1971

Have you ever been sitting at home in the summer, in the evening, air conditioner running like crazy and you're **HOT!** And you feel like you're sitting in your microwave and its on **HIGH!** That sneaky **INFRARED** found its way down through your ceiling.

Everyday Examples of the Power of Aluminum



Thermos Bottle



Baked Potato

IT'S NO JOKE!

What do Emergency Paramedics use for emergency blankets - Reflective Insulation
What do forest firefighters use to protect them from fire storms - Reflective Insulation
What does NASA use to protect our astronauts- Reflective Insulation
Shuttle - Reflective Insulation, the Lunar Module - Reflective Insulation.
Reflective Insulation is an Infrared Block. Low-E is an Infrared Block.

Isn't it time we protect ourselves and our homes with a Low-E Infrared Block.

WE ALL KNOW WE NEED REGULAR INSULATION WITH GOOD "R" VALUES. "R" VALUE IS THE RESISTANCE TO HEAT FLOW - THE HIGHER THE "R" VALUE, THE BETTER IT CAN SLOW CONDUCTIVE AND CONVECTIVE HEAT LOSS

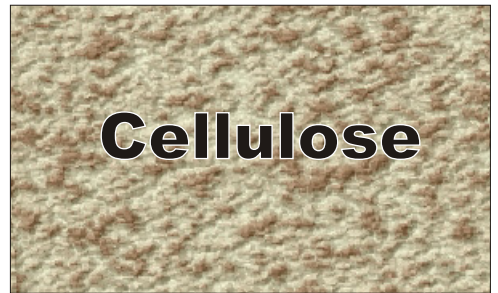
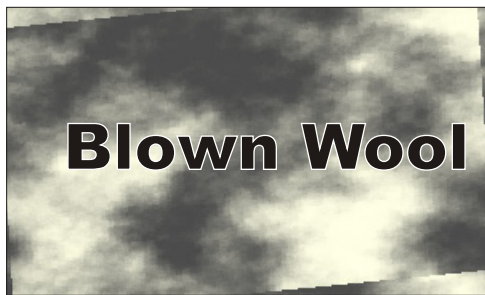

R - VALUE



HOWEVER . . R-VALUES AND REGULAR INSULATION WON'T



RADIANT HEAT LOSS!

Low-E Insulation Will!

What is Low-E Insulation™ ?

Micro-E, Low-E, Econo-E, Ultra-E Insulation™ are the trademarked names of **Environmentally Safe Products, Inc.** The **Low-E Insulation** family of products are the most advanced, quality, reflective insulation products on the market today. These products are constructed of a core of environmentally agreeable foam bonded to two exterior faces of 99.4% pure, highly polished aluminum. **ESP, Inc.** has dedicated themselves to producing a **patented** product that meets the energy needs of today with a product that addresses the concerns of the future by utilizing a polyethylene core that is made with recycled foam.

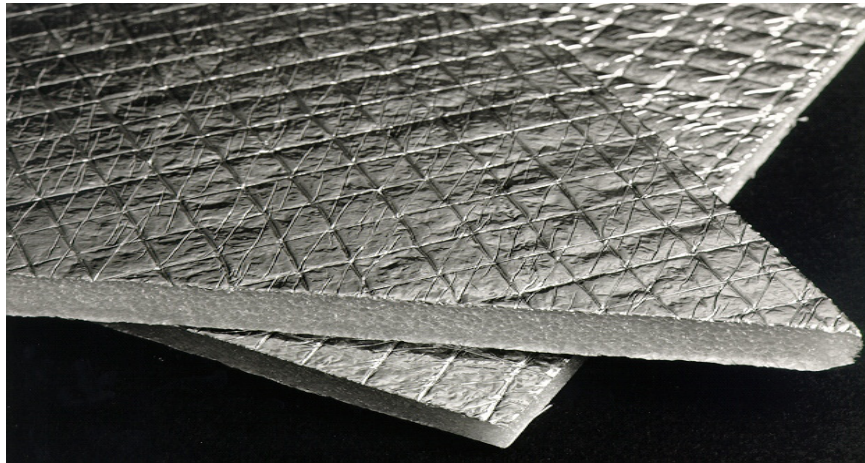

Why Low-E Insulation™ ?

Low-E Insulation™ resists all three types of heat transfer, Conduction, Convection, and most importantly, Radiant Energy Transfer. The design incorporates the proven effectiveness of the Thermos Bottle, with improved flexibility and light weight, that makes installing and handling an enjoyable experience.

Properly installed, **Low-E Insulation™** resists convective currents and provides an excellent barrier against air infiltration from the outside. It also is an excellent vapor retarder.

Unlike other types of mass insulations, **Low-E Insulation™** does not absorb moisture at all. In fact, **Low-E Insulation™** installed in conjunction with mass insulations can help them stay drier and warmer, eliminating dew points that may occur in the mass insulation, improving the performance of the mass insulation.

Customers have been praising **Low-E Insulation™** and reporting back that their comfort levels are improved and their energy bills are reduced.

How can installing Low-E Save Money?



6" of mass insulation slows down only 85 % of conductive and convective heat losses.

A second layer of R-19 only slows down an additional 12% of the heat flow passed by the first layer.

PA Energy Book: "NOTE; If you already have two or three inches of insulation (around R-11) in the attic, adding more insulation is not as cost effective as it would be to add insulation to an attic that has none. Insulation obeys the law of diminishing returns - the more you add, the less heat loss each additional inch or unit of R-value prevents."

YOUR NET RETURN ON YOUR INVESTMENT CAN BE LESS THAN 7% PAYBACK, IN SOME CASES THAT TRANSLATES IN TIME TO UP TO 25 YEARS

Energy Design Update Feb 93 " A sober look at attic R-values in hot climates. Increasing the attic insulation from R-19 to R-30 in Atlanta, Georgia, in a 1500 square foot house would save only about \$5.00 per year in cooling costs (at \$.08 per kwh). **The results show that high R-values simply don't have significant impact on total cooling energy costs in hot climates.**"

C. M. Pelanne, Senior Research Specialist for Johns Manville, Stated "Radiation is the primary mode of all heat transfer. The other two modes, conduction and convection, come into play only as they interfere with the primary mode."

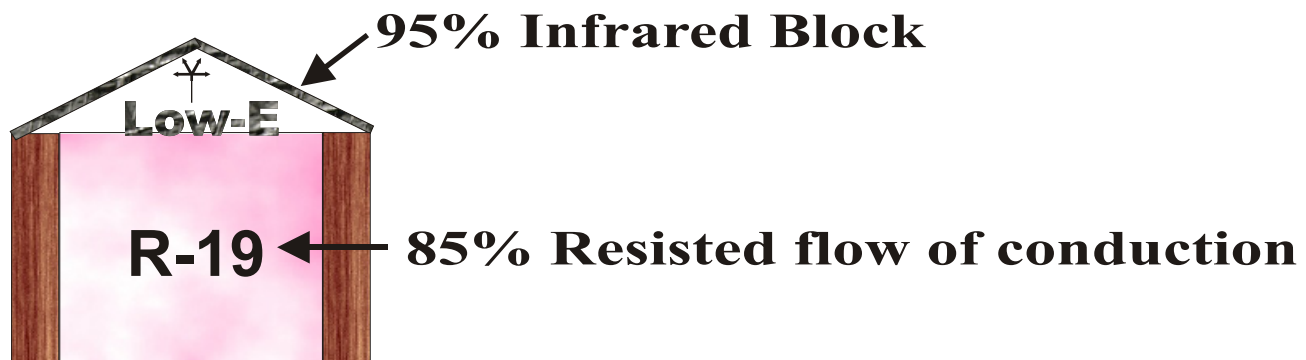

**YOUR NET RETURN ON YOUR INVESTMENT - up to 20%!!
AVERAGE PAYBACK TIME IS 7 YEARS OR LESS**

***IT'S YOUR MONEY, Let
the POWER of ALUMINUM Work for YOU!***

Versatility and uses of Low-E Insulation™

Low-E Insulation™ is an extremely versatile, **patented** form of insulation. It is simple to install and has numerous residential, commercial and recreational applications - thermal resistance, water vapor retarder, wind infiltration barrier, pipe and duct wrap, etc. **Low-E Insulation™** can be used in various applications where traditional insulation is not practical

BENEFITS OF UTILIZING LOW-E INSULATION™

Significantly reduces cost of installation
Maintains consistent System R-Values
Saves money on heating and cooling
Core has excellent memory - absorbs high impacts
Micro-cell core design seals tightly around fasteners
Superior water vapor retarder
Helps control condensation
Excellent fire rating

Light-weight
Stops 97% of radiant energy transfer
Increased comfort levels
Requires no gloves or breathing gear
Clean and non-toxic
Will not harm people, animals or plants
Resists mold, mildew, most insects
Does not attract birds - mice do not nest

Protects environment - uses up to 40% pre- and post-consumer recycled polyethylene foam

WHY DO PEOPLE LOVE USING LOW-E INSULATION™?

Low-E Insulation™ is easily installed with the use of a razor knife or scissors, a staple gun, tape measure and ESP foil tape.
And there are no itchy fibers!

Many uses for Low-E Insulation™ and Low-E products

INCLUDE (BUT ARE NOT LIMITED TO):

- * Stud walls
- * Under rafters (new or retrofit)
- * Under crawl spaces
- * Pipe and duct wrap
- * Re-usable air conditioner covers
- * Between concrete walls and interior panels
- * Overhead door insulation
- * Metal building side walls
- * Hot water heater blanket
- * Car, van and RV applications
- * Survival blankets
- * Food storage and coolers

Low-E Applications

Wall Application with Low-E (no mass insulation) (2" x 4" stud)

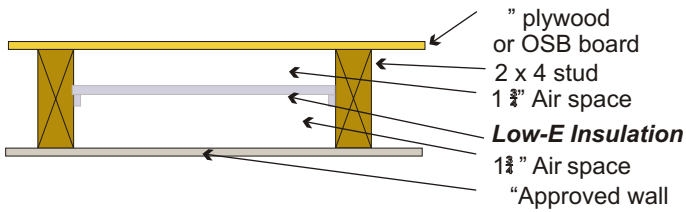

Average System R-value R - 7.75
Horizontal Heat Flow Only
E-value 0.03

Pipe Wrap Application

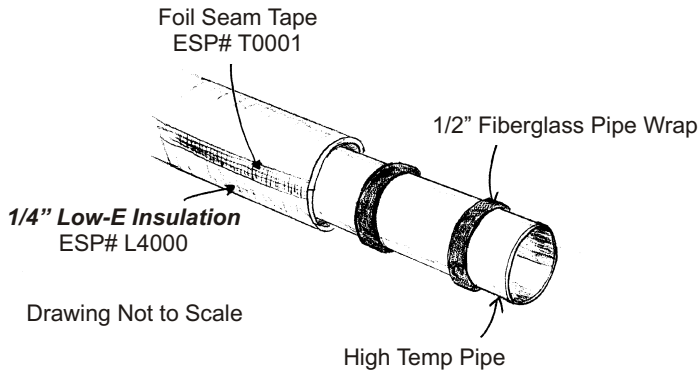

Drawing Not to Scale

In this example we are showing one method of insulating a high temperature pipe. The 1/2" fiberglass pipe wrap is used as a spacer to create an airspace, preventing direct contact with the **Low-E insulation** and the pipe. The Low-E is wrapped around the pipe and the seam is taped with Low-E tape.

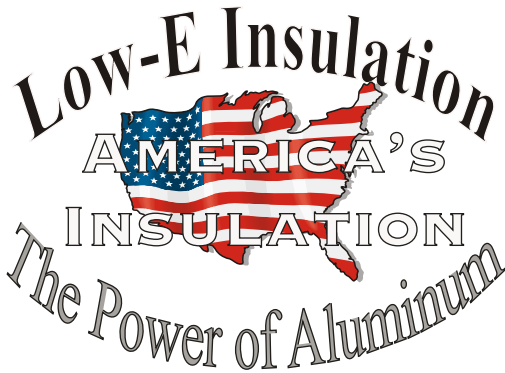

Environmentally Safe Products, Inc.

313 West Golden Lane
 New Oxford, PA 17350
 Phone; (717) 624-3581
 Phone: 1-800-BUY LOW-E
 FAX (717) 624-7089

Doc#8004.12

These are just a few examples of the many uses of this versatile product. Besides the normal applications in buildings, Low-E Insulation has been used in applications ranging from food packaging to race cars. It is the unique design and construction of Low-E Insulation that makes it so universal. Anything that requires a product to control heat can use Low-E Insulation.

Duct Wrap Application

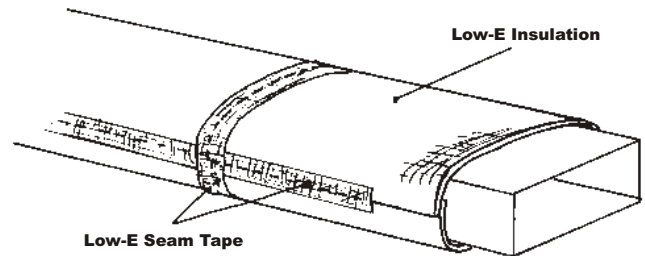

This installation is one example of a duct wrap. Another application would be to use the supplied spacer to create an air space for greater thermal efficiency. More detailed instructions available upon request.

Water Heater Jacket

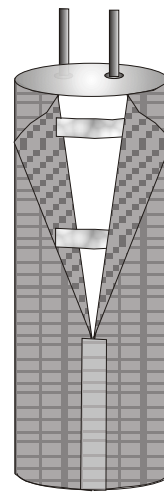

Environmentally Safe Products, Inc. has a kit available to add extra energy efficiency to your water heater. The concept is simple, by adding a blanket of **Low-E Insulation** around your water heater you are creating a thermos bottle® to retain heat. Ordinary water heater wraps are made with mass insulation that only slows down the transfer. Low-E has an emissivity of 0.03 which means that only 3% of the radiant energy is allowed to pass. In tests performed, Low-E provided savings with even the most efficient water heaters. Instructions for installation are included in the kit.

DEALER