

# HouseWrap Applications

System R-Value: R-4.17 Horizontal Heat Flow Only

## Installation Method (Existing Walls)

1. ESP Low-E® Housewrap is installed over exterior wall sheathing, make sure reflective side faces out: foil flange faces down.
2. Determine width of ESP Low-E® HouseWrap being used (4', 5', 6') for initial wrap (lowest point of wall surface)
3. Measure from sill plate up the wall, mark wall at level of determined width less 1" i.e. 5' ESP Low-E® HouseWrap mark at 59"
4. Snap chalkline around perimeter
5. Starting at the corner of the preferred exterior wall unroll ESP Low-E® Housewrap in a horizontal manner. Fasten using corrosion resistant staples having minimum 1" wide crown, corrosion resistant nails having minimum 3/8" heads or corrosion resistant nails having minimum 1" diameter plastic heads. Fasteners to be spaced a maximum of 16" both vertically and horizontally.
6. When rolling ESP Low-E® Housewrap over door and window openings: If windows and doors have been set, trim ESP Low-E® HouseWrap as close to window or door opening as possible and perform detailing as per door / window manufacturer and or code standards.
7. The bottom side of the ESP Low-E® Housewrap should extend over sill plate by minimum 1".
8. When applying second horizontal run of ESP Low-E® Housewrap butt foam ends together allowing foil flange to overlap 2". Make certain foil flange is to the outside to ensure water drainage plane downward.
9. Tape all vertical and horizontal flange seam areas with foil tape.
10. Continue method until ESP Low-E® Housewrap covers both top plates.
11. Use foil tape to repair areas that have been torn or compromised. (See page 7)
12. **Foil is a conductor of electricity. Use extreme caution when working with ESP Low-E® Housewrap around power lines, wiring and electrical devices.**

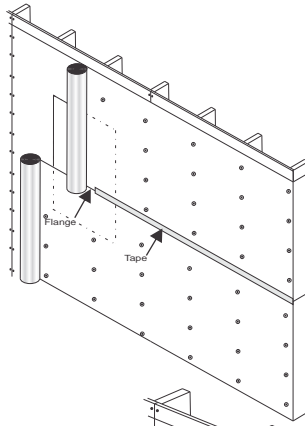

1. When coming to the end of existing roll in use, leave up to 12 inches of product unattached to wall system.
2. Remove new roll from packaging
3. Unroll ESP Low-E® Housewrap to desired area making sure that product is plumb and square with housewrap already in place and also overlap material past the end of previous material by approx 8 inches.
4. Locate center of overlapped materials and make common splice through both layers of material using utility knife.
5. Remove cut material from end of previous roll and start of new roll
6. Apply Low-E Tape over common splice, then continue installing ESP Low-E® Housewrap as described in Figure 1
7. If vertical splice is not performed, product must be overlapped by minimum of 6"

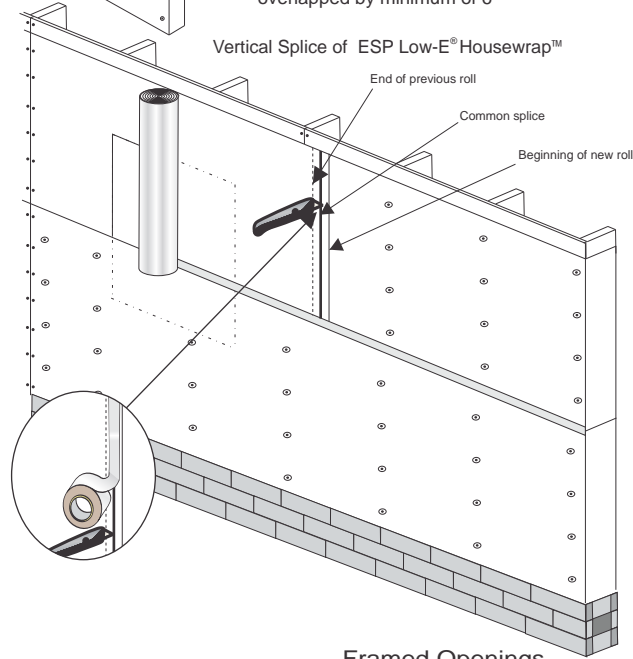

## Penetration Installation Diagrams

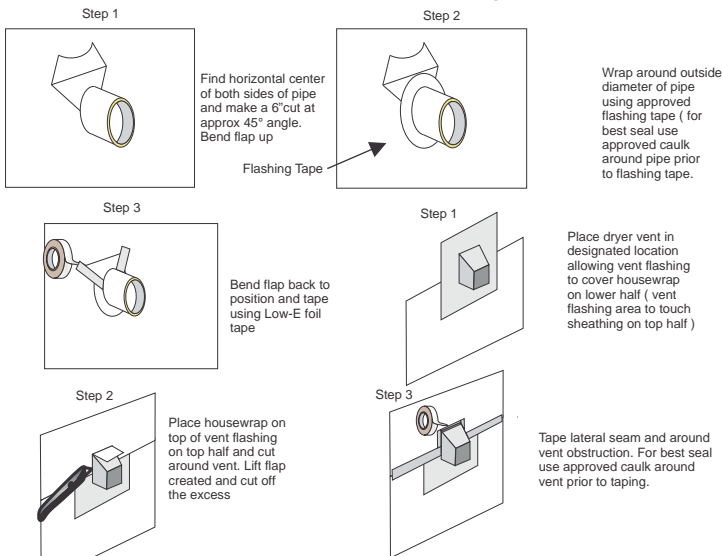

Wrap around outside diameter of pipe using approved flashing tape (for best seal use approved caulk around pipe prior to flashing tape).

Place dryer vent in designated location allowing vent flashing to cover housewrap on lower half (vent flashing area to touch sheathing on top half)

Tape lateral seam and around vent obstruction. For best seal use approved caulk around vent prior to taping.

## Tears and Holes Repair

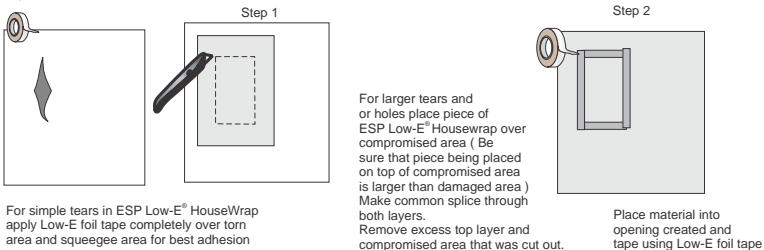

## Framed Openings

When installing ESP Low-E® Housewrap over the exterior of structure be sure to run product horizontally over entire wall including framed openings. (please refer to page 5 for more detailed instructions)

Once ESP Low-E® Housewrap has been securely fastened to exterior sheathing make cuts as shown in Figure 2. Try not to cut past exterior side of framed opening (exception for top of framed opening) but in the event that occurs use Low-E foil tape to repair area that was compromised.

1. An additional flap should be cut above the top exterior side of framed opening for the installation of head flashing.
2. Bend flap away from wall to allow installation of window and flashing
3. Apply window and head flashing
4. Reset ESP Low-E® Housewrap and tape seams

Once side and bottom flaps have been cut, bend these flaps toward the interior of structure using staples or adhesive to attach ESP Low-E® Housewrap to the face of the jamb.

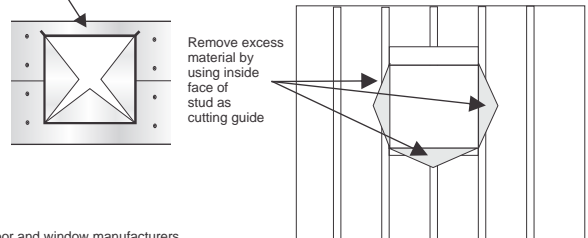

Follow door and window manufacturers instructions for flashing and installation relating to their respective products.

SYSTEM R-VALUE CALCULATIONS FOR THIS ASSEMBLY WERE PERFORMED BY R & D SERVICES REPORT # RD03224

# Pre Engineered Steel Applications

## Commercial Metal Roofing

Average System R-Value: Down R- 11.04, Up R- 7.39

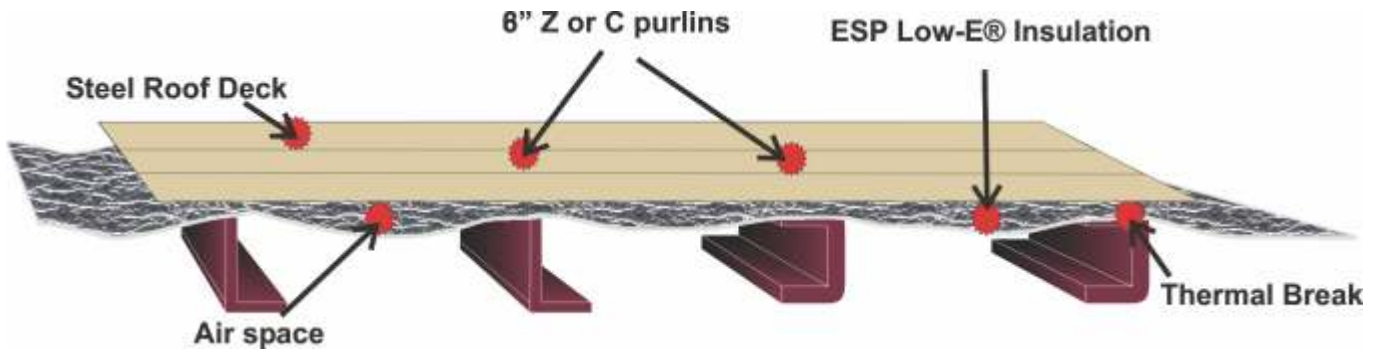

Average System R-Value: Down R- 21.04 (3" Fiberglass), Down R- 30.04 (6" Fiberglass)  
Up R- 17.38 (3" Fiberglass), Up R- 26.39 (6" Fiberglass)

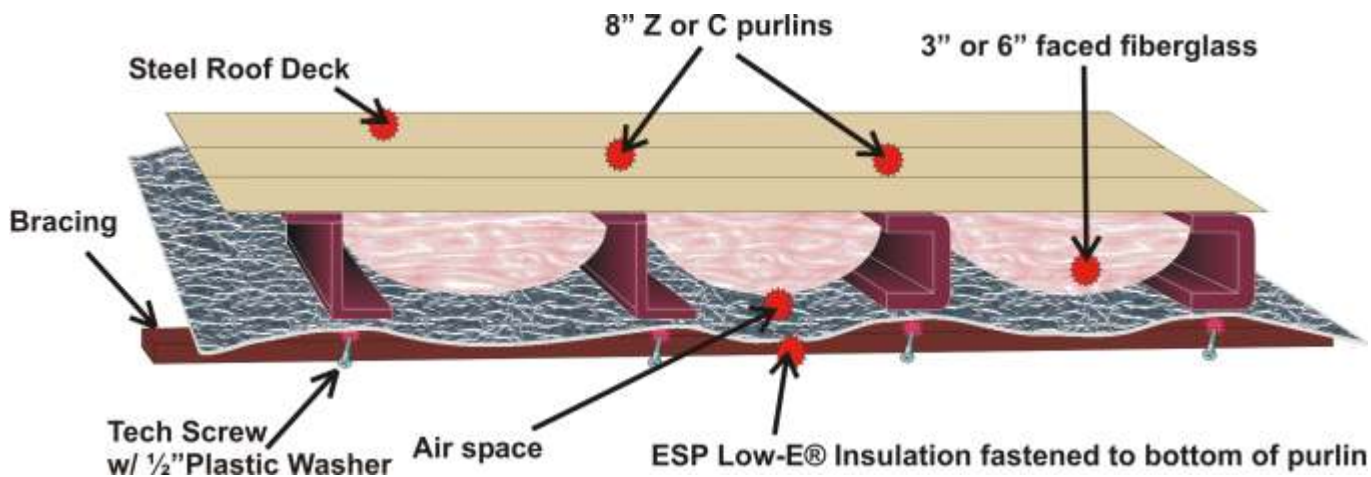

SYSTEM R-VALUES FOR ESP LOW-E® INSULATION AS PER ASTM C-976, AIR TO AIR, ADJUSTED TO MEET CRITERIA EQUIVALENT TO ASTM 1224

## ASHRAE 90.1 Compliance Application

Average System R-Value: R- 17.85 (3" Fiberglass) \*SDR, R- 21.73 (3" Fiberglass) \*SSR, R- 18.51 (4" Fiberglass) \*SDR  
R- 26.31 (6" Fiberglass) \*SDR, R- 30.30 (6" + 3" Fiberglass) \*SSR, \*SDR = Screw Down Roof \*SSR = Standing Seam Roof

### ESP Low-E® Insulation and ASHRAE 90.1 System Patent Pending

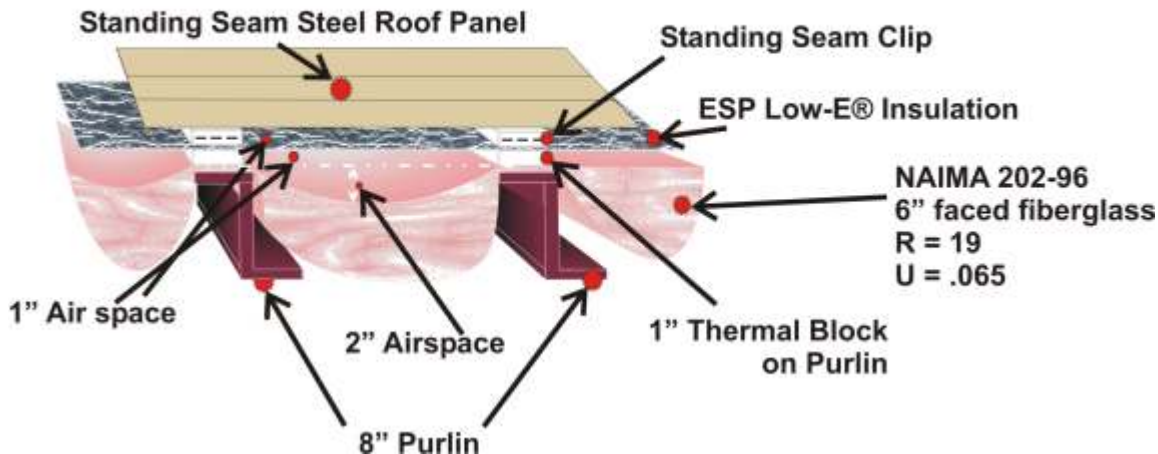

SYSTEM R-VALUES CALCULATED USING ENVSTD 4.0 ESP LOW-E® INSULATION AS R-11 SHEATHING

# Ceiling Applications

## Ceiling Application with Low-E & Blown In Insulation

System R-Value: R- 34.70 Downward Heat Flow, System R-Value R- 33.75 Upward Heat Flow

Measure entire ceiling joist area to determine square footage of Low-E Insulation required (length x width). Roll out material and fasten to bottom of ceiling joist, stapling with 1/2" staples every 6". To achieve a vapor barrier, all adjoining seams must be taped securely with Low-E tape. Secure lathe strips and interior ceiling using approved application methods.

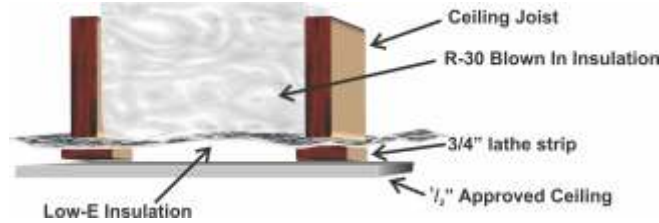

## Recessed Ceiling Application with Low-E & Blown In Insulation

System R-Value: R- 38.04 Downward Heat Flow, System R-Value R- 32.87 Upward Heat Flow

Measure entire ceiling joist area to determine square footage of Low-E Insulation required (length x width). We recommend using Low-E Insulation with tabs. Roll out tab material and fasten by recessing it 1-1/2" into ceiling joist cavity, stapling with 1/2" staples every 6". To achieve a vapor barrier, all adjoining seams must be taped securely with Low-E tape. Secure interior ceiling using approved application methods.

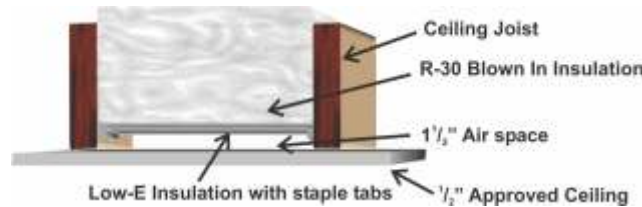

SYSTEM R-VALUES FOR THESE INSTALLATION METHODS WERE CALCULATED USING DATA FROM THE 1989 ASHRAE HANDBOOK OF FUNDAMENTALS

## Suggested Cathedral Ceiling Installation

System R-Value: R- 29.74 Downward Heat Flow, R- 23.55 Upward Heat Flow

Install 24" ESP Low-E® Tab Insulation as the baffling under wood deck to insure proper ventilation. Install fiberglass according to manufacturers recommendation.

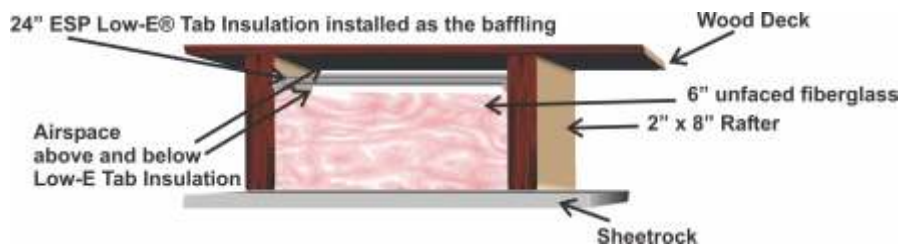

Different climates may affect application. Refer to local building codes for placement of vapor barrier. Low-E is a vapor barrier.

# Attic Applications

## Attic Rafters / 1/8" Low-E Insulation

### Low-E Roof Rafter Application

\*Do Not Use Attic floor insulation In Rafter Applications

Lathe Strips, Metal Banding or Fireproof Fiberglass strips for additional support

Micro-E Insulation

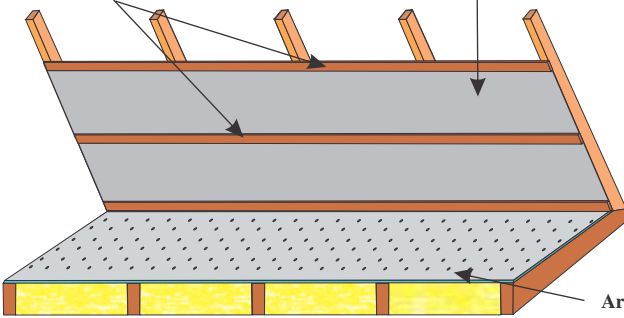

Lathe Strips, Metal Banding or Fireproof Fiberglass strips for additional support

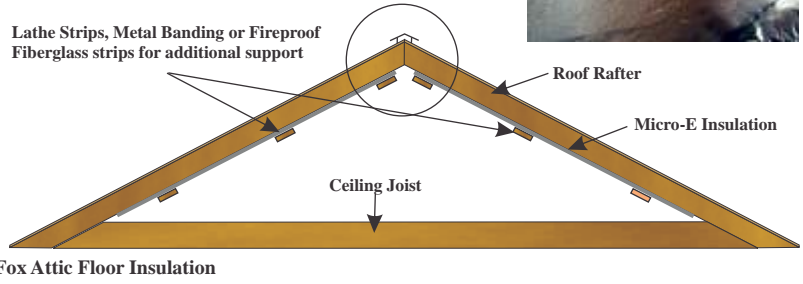

Arctic Fox Attic Floor Insulation

This installation below is for retrofitting rafters as an energy upgrade. Low-E Insulation is installed across the bottom face of the rafter. Proper ventilation must be maintained. Measure rafter area to determine square footage of Low-E Insulation required (length x width). Roll out material and fasten to bottom of rafter face with 1/2" staples approximately every 6 inches. We suggest starting at the peak and working down to the eave. Leave approximately 1/2" space at the peak for ventilation. All adjoining seams must be taped securely with Low-E tape, unless a staple flange product is used. To prevent insulation from falling from rafters, ESP recommends using lathe strips, metal banding or fireproof fiberglass strips for added

Note: Drawings are not to scale and are meant to depict possible applications. Exact Specifications may vary See Attic Floor Insulation Install Guide for further instructions.

## Attic Floor Insulation

### Low-E Attic Floor Insulation Application (with mass insulation)

Low-E Attic Floor Insulation

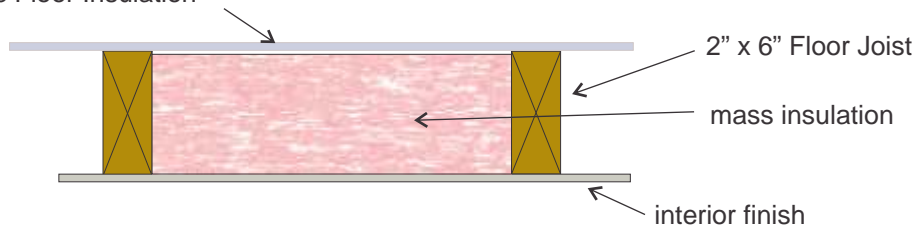

Low-E Attic Floor Insulation can be rolled out over existing mass insulation. The product is perforated and will not trap moisture. Low-E Attic Floor Insulation can be stapled with 1/2" staples every 6". Since it is not a vapor barrier taping of seams is optional.

Low-E Attic Floor Insulation 4' width

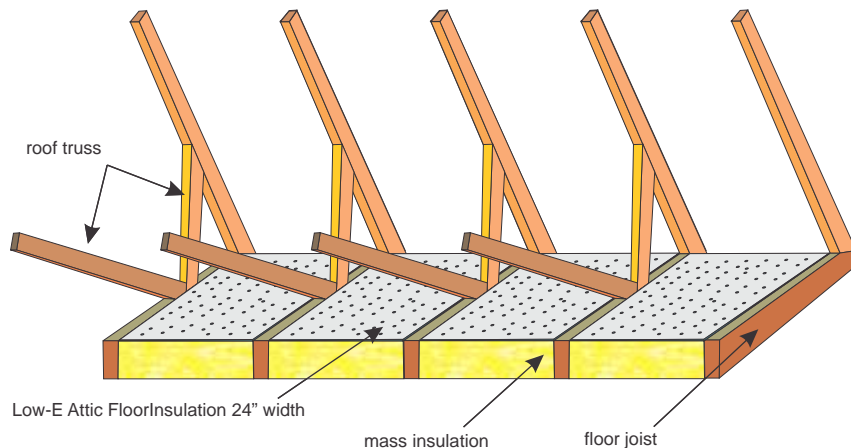
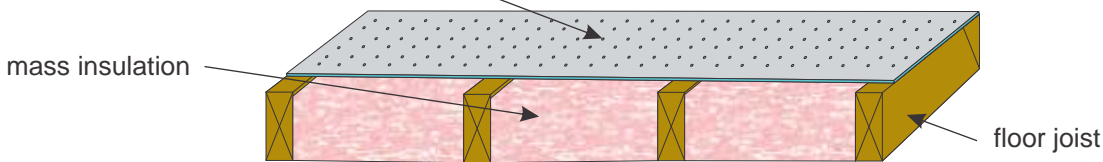

# Roofing Applications

## New Construction Over Roof Rafter Installation

System R-Value: R- 11.04 Down, R- 7.29 Up

After roof truss or roof rafters have been located and installed, install Low-E Insulation® by drooping approx. 2" at center of span over the truss/rafters. Use staples to attach material. To assure a proper vapor barrier, all seams should be taped securely with Low-E tape. If continuous roof/ridge vent is to be installed, insulation should stop approx. 2" from vent to allow flow of air out of roof system.

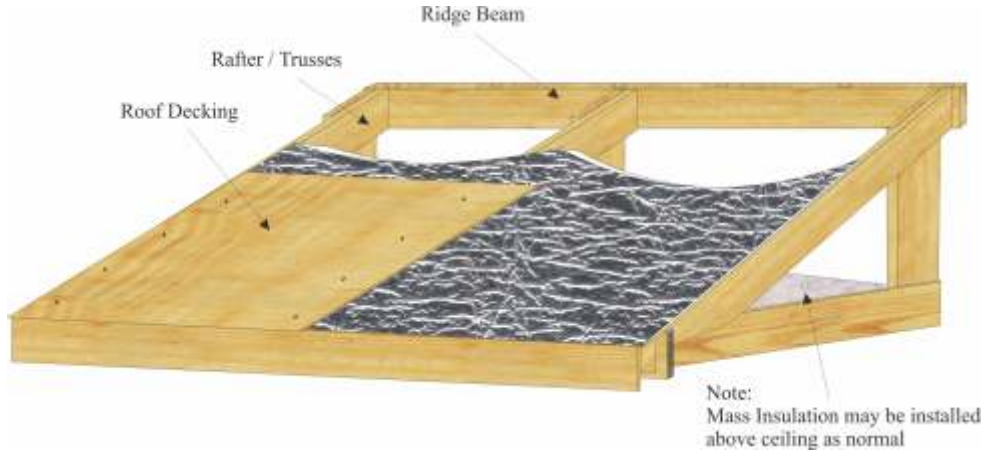

SYSTEM R-VALUES FOR THESE INSTALLATION METHODS WERE CALCULATED USING DATA FROM THE ASHRAE HANDBOOK OF FUNDAMENTALS

## Residential Metal Roof Installation

Average System R-Value: R- 9.15 Down

Furring boards provide airspace between top of ESP Low-E® Insulation and underside of metal roof.

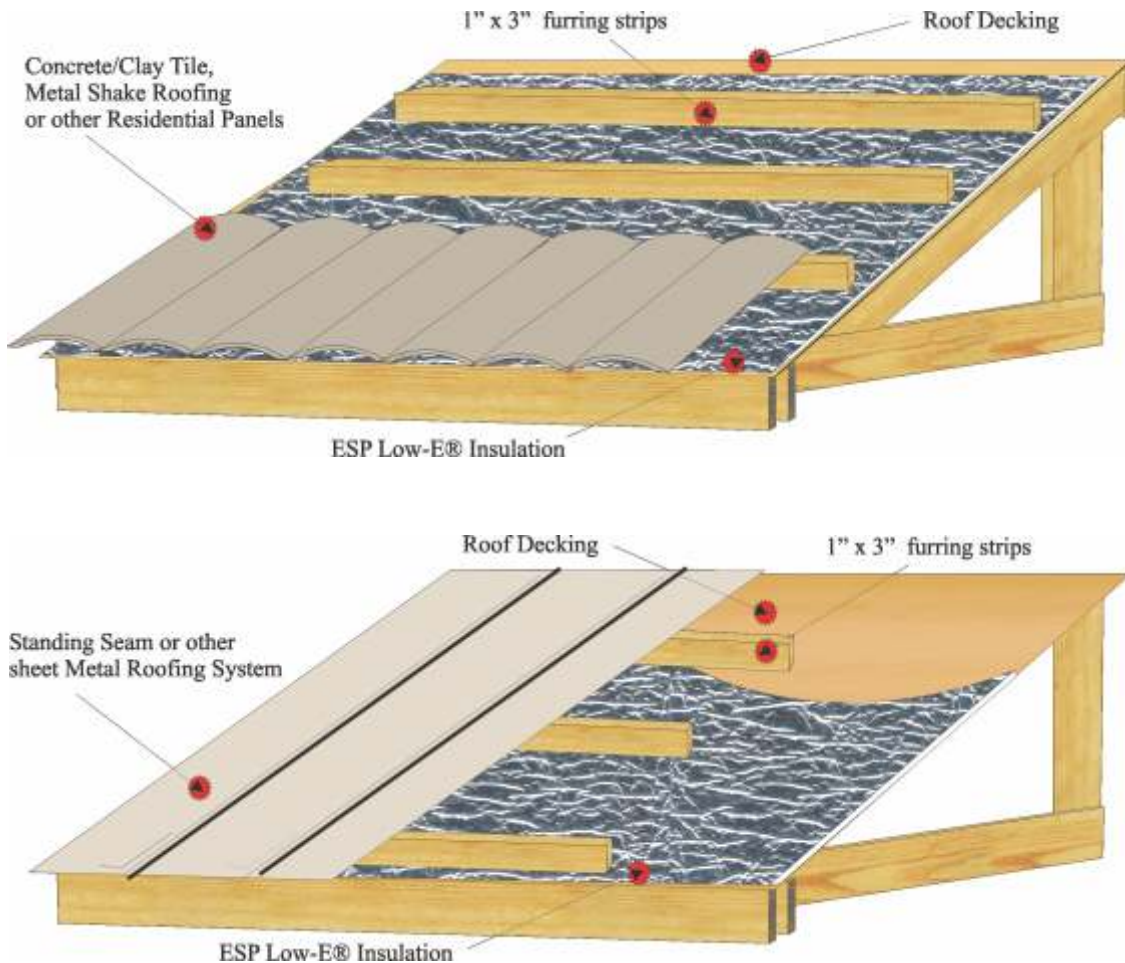

SYSTEM R-VALUES FOR THESE INSTALLATION METHODS WERE CALCULATED USING DATA FROM THE ASHRAE HANDBOOK OF FUNDAMENTALS

# Wall Applications

## Wall Application with Low-E & Mass Insulation (2X4) & (2X6)

System R-Value: R- 18.91, Horizontal Heat Flow Only

The first step in this application is to install mass insulation in the wall cavity. Next, install Low-E Insulation Tab Material with the tab flush to the outside of the stud. It is recommended that 1/2" staples be applied approximately every 6" along tab to fasten Low-E. All seams should be taped securely with Low-E Tape. Cover the face of each stud with tape and all seams around electrical boxes should be taped.

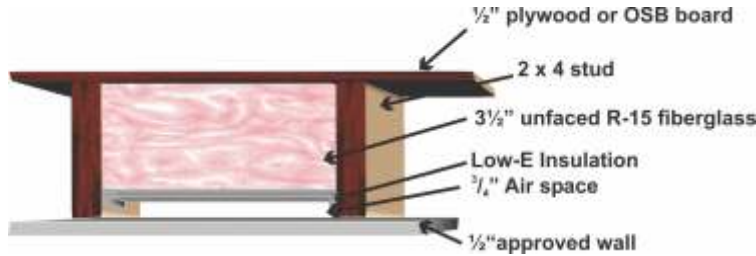

System R-Value: R- 22.75, Horizontal Heat Flow Only

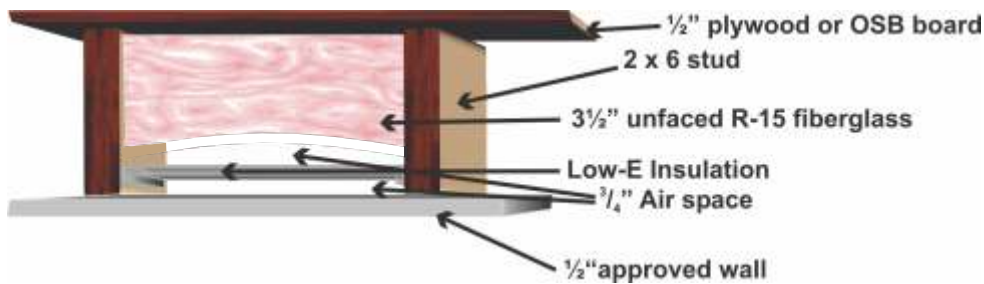

SYSTEM R-VALUES FOR THESE INSTALLATION METHODS WERE CALCULATED USING DATA FROM THE ASHRAE HANDBOOK OF FUNDAMENTALS

## Wall Application with 1 Layer Low-E Insulation (No Mass Insulation)

System R-Value: R- 9.06, Horizontal Heat Flow Only

Install Low-E Insulation Tab Material with the tab centered within the stud cavity. It is recommended that 1/2" staples be applied approximately every 6" along tab to fasten Low-E. All seams are taped securely with Low-E Tape. All seams around electrical boxes are taped. To achieve a vapor barrier, all seams must be taped securely with Low-E tape.

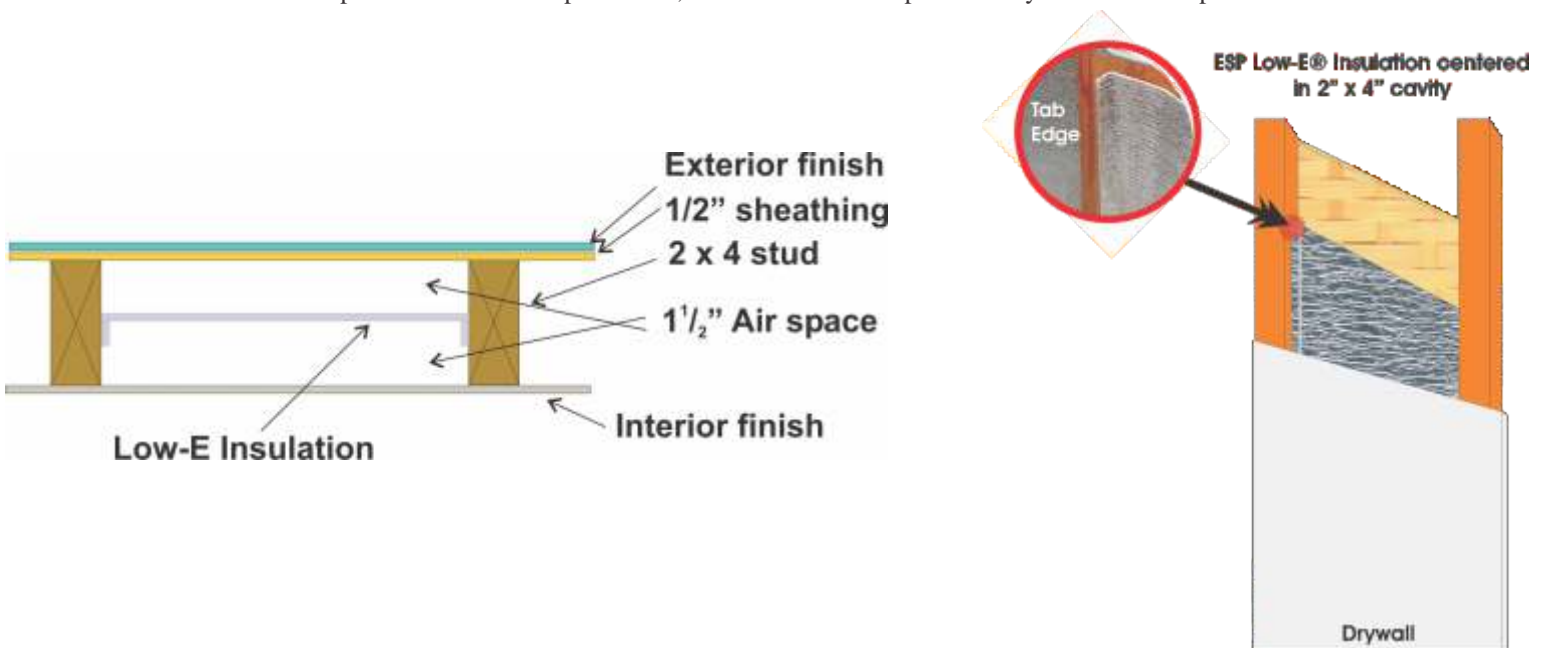

CALCULATIONS FOR THIS ASSEMBLY WERE PERFORMED BY R & D SERVICES REPORT # RD03224



Econo-E® Insulation  
Reduces your carbon footprint.



## ESP LOW-E®: ECONO-E® INSULATION

PRODUCT CODES\*: 4EFET, 6EFET(trimmed), 4EFES, 6EFES(staple flange), 4EFEZ, 6EFEZ(ez seal)

PRODUCT DIMENSIONS & DESCRIPTION\*

Double sided scrimless aluminum foil laminated to polyethylene foam (1/4" nominal thickness)

Edges can be trimmed, with staple flange or with EZ-Seal self taped flange feature.

WIDTH\*\*: 4', 6' respectively

LENGTH\*\*: 125' (stock size 4'width) 84' (stock size 6' width)

R-Value\*\*\* : R-11 down R-7.55 up R-7.75 horizontal

PERM RATING: ASTM E-96 0.008

FLAME AND SMOKE: ASTM E-84 Flame spread <25 Smoke developed <50

FULL SCALE FIRE TEST: NFPA-286 Passed

EMITTANCE: ASTM C-1371 0.03

\* This label refers to the Econo-E® line of insulation products supplied by ESP, Inc. and includes information on different widths and attachment features of the Econo-E® line. Refer to thermal label affixed to the roll of insulation for information on specific product purchased.

\*\* Additional widths and lengths are available upon request and approval by ESP, Inc.

\*\*\* R-value results are obtained from ASTM C236. R-values for Econo-E® materials can be higher or lower depending upon application.

Specific R-values for specific applications can be obtained from Install Guide at [www.low-e.com](http://www.low-e.com) or by contacting ESP, Inc. at 1-800-289-5693

"R means resistance to heat flow. The higher the R-value, the greater the insulating power." "To get the marked R-Value, it is essential that this insulation be installed properly. If you do it yourself, get instructions and follow them carefully. Instructions do not come with this package." To obtain installation instructions visit [www.low-e.com](http://www.low-e.com) or call 1-800-289-5693. Like a radiant barrier, Low-E products also block 97% of radiant heat.

ESP, Inc. strives to provide the most accurate R-Value data possible. The R-Values set forth in this document are the reflection of a combination of industry standard testing and conscientious calculations. However, these numbers, even within specific applications can fluctuate due to the multiple variables that influence R-Values.

**NOTE:** Do not allow product to become damp or wet while rolled in sealed bag  
Do not set product directly on wet or uncured concrete.

**WARNING:** Although ESP LOW-E® Insulation Products are all fire tested to ASTM and/or NFPA standards; it is recommended that they or any insulation material should not be exposed to open flame or other ignition sources of sufficient intensity during shipment, storage or installation.

**CAUTION:** Aluminum is an electrical conductor. Please use caution when working around electrical sources including overhead power lines. Carefully inspect electrical junction boxes and check for frayed wires before beginning installation

Note: ESP Econo-E® is a versatile product for many applications and industries.



Environmentally Safe Products, Inc.  
313 W. Golden Ln. New Oxford, PA 17350  
Toll Free: 1-800-289-5693 Fax: 717-624-7089  
[www low-e.com](http://www.low-e.com) E-mail: [sales@low-e.com](mailto:sales@low-e.com)



Scan code to see  
Install Guide

copyright@espaug1.2012